



ekey home

en OPERATING INSTRUCTIONS

Table of contents

General	3
Note	3
Declaration of conformity	3
Product liability and limitation of liability	3
Warranty and manufacturer's guarantee	3
Copyright protection	3
Notices, symbols, and abbreviations	4
Safety information	5
Risk of electrocution	5
Tamper-proofing	5
Product description	6
System overview.....	6
Scope of delivery.....	6
Proper use and area of application	6
Finger scanner	7
Code pad	10
Control panels	12
Technical specifications	13
Installation and activation	15
Activating the system	15
Performing test mode	17
Operating concept	18
Configuration of normal mode and usage of the finger scanner with the app	19
Downloading the app	19
Coupling a mobile device for the first time.....	20
Changing security codes.....	21
Storing fingers	22
Disabling Bluetooth.....	23
Coupling additional mobile devices.....	23
Managing multiple Bluetooth finger scanners	24
Storing the user coupling code	25
Resetting the app security code	25
Protecting the system in the event that the mobile device is lost	26
Opening a door	27

Configuration of normal mode and usage of the finger scanner with administrator fingers.....	29
Storing administrator fingers and configuring normal mode.....	29
Storing user fingers	31
Storing RFID transponders.....	33
Opening a door	35
Deleting user fingers.....	37
Deleting RFID transponders	38
Deleting all user fingers and RFID transponders	39
Configuration of normal mode and usage of the code pad with shortcuts	41
Entering the admin code.....	41
Changing the admin code	43
Setting the automatic back-illumination	45
Setting the brightness of the back-illumination.....	46
Setting the relay switching duration	47
Setting the signaling that indicates when a button has been pressed	48
Setting an acoustic signal for opening.....	49
Storing the user code.....	50
Opening a door	52
Deleting the user code	53
Resetting the system to default settings	54
Via the app.....	55
Via the finger scanner	55
Via the code pad	57
Via the control panel	58
Via the digital input (<i>ekey home control panel micro 1 only</i>).....	59
Updating the software.....	59
Error displays and troubleshooting.....	60
Finger scanner	60
Code pad	62
Maintenance	63
Disposal.....	63

General

Read these operating instructions carefully before use. These operating instructions form a component of the product. Ensure that they are stored in a safe place. These operating instructions contain important information on the product; in particular, its proper use, safety, installation, activation, usage, maintenance, and disposal.

Please contact your dealer for further information about the product.

A large-font version of these operating instructions is available at <http://www.ekey.net>.

These operating instructions are not subject to updating. We reserve the right to make technical modifications and change the product's appearance; any liability for errors and misprints is excluded.

ekey biometric systems GmbH hereby declares that the product conforms to the relevant European Union directives.

Safe operation and function of the devices can be impaired in the situations outlined below. In the event of malfunctions, damage, consequential damage, costs, or expenses associated directly or indirectly with the use of the instructions or the products that they describe, liability shall transfer to the operator/user in the following cases:

- The system devices are not installed, used, maintained, or cleaned in accordance with the instructions
- The system devices are not used within the scope of proper use
- Unauthorized modifications are carried out on the system devices by the operator.

The version of our general terms and conditions in force on the date of purchase shall apply. See <http://www.ekey.net>.

Copyright © 2019 ekey biometric systems GmbH.

All content, artwork, and any ideas contained in these operating instructions are subject to applicable copyright laws. Any transmission, relinquishment, or transfer of this content or parts thereof to any third party requires the prior written consent of ekey biometric systems GmbH. Translation of the original documentation.

Note

Declaration of conformity

Product liability and limitation of liability

Warranty and manufacturer's guarantee

Copyright protection

Notices, symbols, and abbreviations



DANGER

Denotes imminent danger which could lead to death or serious injuries.



ATTENTION

Denotes possible property damage which cannot result in injuries.



NOTICE

Denotes additional information and useful tips.

Symbols:

1.	Step-by-step instructions
	References to sections of these instructions
	References to the mounting instructions
	References to the wiring diagram
□	Listing without specified order, 1st level
<u>Displayed value</u>	Displayed values
<i>ekey home CP</i> <i>mini</i>	Product names
MENU ITEM	Menu items
	Buttons

Abbreviations and terminology:

BT	Bluetooth
CP	Control panel
FAR	False acceptance rate
FRR	False rejection rate
FS	Finger scanner
IN	integra
KP	keypad
OM	Outlet-mounted
RFID	Radio-frequency identification
WM	Wall-mounted
Fingerprint	The biometric information extracted from the fingerprint
Normal mode	Default operating status in which the system is operated.
Registration unit	Finger scanner or code pad

Safety information

DANGER



All *ekey home* devices are to be operated with safety extra-low voltage (SELV). Only use power supplies rated protection class 2 according to EN 62368-1.

Failure to do so will create a risk of fatal electrocution.

Only certified electricians are authorized to carry out low-voltage electrical work on electrical systems!

Risk of electrocution

Mount the control panel in a secure internal area. This prevents tampering from the outside.

Tamper-proofing

Product description

System overview

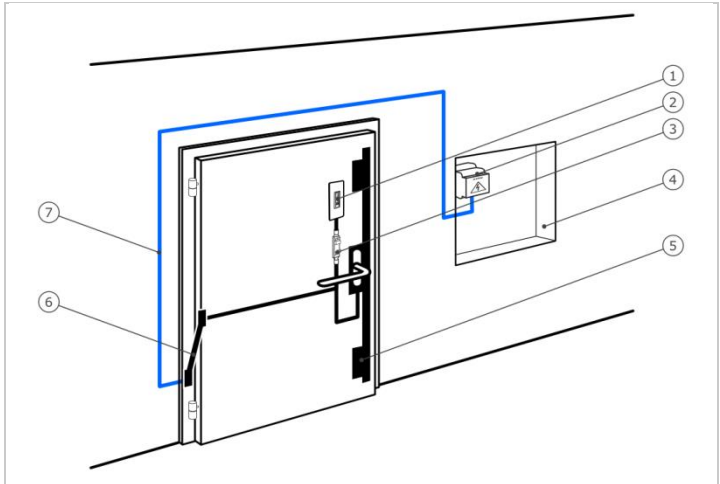

Fig. 1: Overview of the system

- 1 Registration unit
- 2 Power supply
- 3 Control panel
- 4 Distributor box
- 5 Motorized lock
- 6 Cable transfer
- 7 Connecting cable

Scope of delivery

- Registration unit
- RFID transponder for finger scanners with RFID function
- Control panel
- Operating instructions, mounting instructions, wiring diagram
- Optional: matching accessories (cable transfer, power supply, connecting cable, covers, etc.).

Proper use and area of application

This product is an access control system with a biometric or mental identification feature (finger scan or pin code). The system is comprised of a registration unit and control panel. It is available in various models and component combinations.

The biometric access control system detects the characteristics (minutiae) of the fingerprint contours, compares them to the biometric information saved from the reference fingerprint image, and opens the door in the event of a match. One variant allows the user to be identified and the door opened by means of an RFID transponder.

The non-physical access control system detects the pin codes which are entered, compares them to the stored reference codes, and opens the door in the event of a match.

The system is primarily designed for opening house doors, apartment doors, and garage doors in homes and businesses.

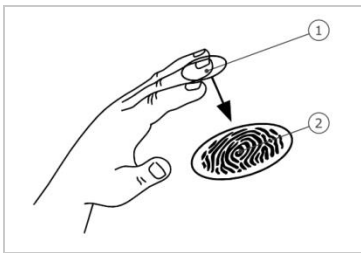

- 1 Front phalanx
- 2 Fingerprint

Fig. 2: Fingerprint

The finger scanner detects the fingerprint by means of a line sensor and subsequently processes it. It compares the result with that of the biometric information saved from the reference fingerprint image and opens the door in the event of a match. The finger scanner only works correctly and reliably with the front phalanx print. Swipe your finger steadily and evenly over the sensor in the correct position.

The variants with RFID function detect and identify RFID transponders.

Finger scanner controls

Controls	Function
Finger swipe area	Store fingers by 'swiping the finger' evenly downward over the sensor. Identification by 'holding up the RFID transponder', which involves holding an RFID transponder over the finger swipe area of the finger scanner.
Sensor	System programming by 'Finger Touch', a short, rapid touch of the sensor with the finger.

Table 1: Finger scanner controls

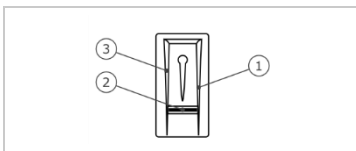





- 1 Right guiding edge
- 2 Sensor
- 3 Left guiding edge

Fig. 3: Finger swipe area and sensor

Correct operation of the finger scanner

Incorrect operation will impair the function of the finger scanner.

'Swiping the finger':

Step	Figure	Description
1st		Hold your finger straight and place it centrally between the guiding edges. Do not twist the finger.
2nd		Place the joint of the front phalanx directly onto the sensor. Place your finger flat onto the finger swipe area.
3rd		Stretch out the neighboring fingers.
4th		Move your finger evenly downward over the sensor. Move the whole hand simultaneously. Swipe the front phalanx fully over the sensor in order to achieve optimal results. The movement takes approx. 1 second.

General hints for achieving a good-quality fingerprint

- The index, middle, and ring fingers work best. The thumb and small finger supply fingerprints that are difficult to analyze.
- In the case of fingers that are frequently wet, store the images with wet fingers.
- Children's fingerprints work from approx. 5 years of age.

'Finger Touch':

Step	Figure	Description
1st		Briefly touch the sensor with your finger.

'Holding up the RFID transponder':

NOTICE



The 'holding up the RFID transponder' option is only available for finger scanners with an RFID function.

Step	Figure	Description
1st		Hold the RFID transponder face parallel to the finger swipe area of the finger scanner at a distance of 1 to 5 cm.

Optical signals on the finger scanner

There are 2 types of LED:

- Status LED for operating status
- Function LED for indicating the function of the overall system.

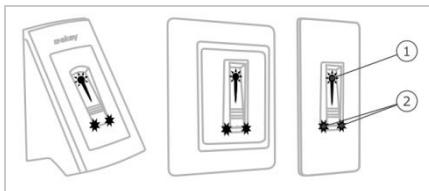

- 1 Status LED
- 2 Function LEDs

Fig. 4: Optical signals on the finger scanner

Function of the code pad

The code pad captures the pin code with the capacitive keypad. The code pad compares what has been entered with the stored reference codes. The code pad can handle pin codes containing 4 to 8 digits. The digits in the pin code cannot all be the same; at least one of them must be different. There are 2 types of pin code: The admin code for configuring the system and the user code for opening doors.

If the code is entered incorrectly 3 times, there will be a 1-minute lock. If the code is then entered incorrectly a further 3 times, there will be a 15-minute lock. There will be a 15-minute lock each time the code is entered incorrectly after that.

Controls, optical signals, and acoustic signals on the code pad

The code pad has 2 sections with controls.

Controls	Function
Input buttons	Enter pin code; select menu item.
Confirmation buttons	Confirm pin code input as positive or negative; start menu.

Table 2: Code pad controls

2 status LEDs signal the operating statuses (pin code correct, pin code incorrect, menu item, etc.). An acoustic signal transmitter signals that the button has been pressed and that access has been enabled.

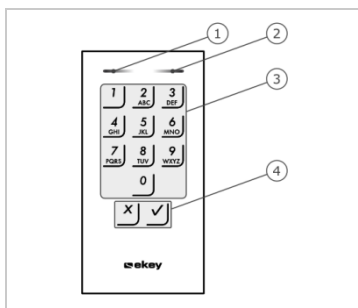

- 1 Left status LED
- 2 Right status LED
- 3 Input buttons
- 4 Confirmation buttons

Fig. 5: Code pad overview

The back-illumination of the keypad is blue, dimmable, and switches on or off according to the lighting conditions.

Admin menu structure of the code pad

There is a range of menu items available in the Admin menu for programming purposes. These can be called via the buttons.





Button	Menu item
	Store user code
	Delete user code
	Change admin code
	Reset system to default settings
	Set code pad (back-illumination, relay switching duration, acoustic and optical signal when button is pressed, acoustic signal on opening)

Table 3: Admin menu structure of the code pad

NOTICE



The code pad switches back to normal mode after 10 seconds if nothing has been pressed. When this happens, any inputs or changes that are attempted will be rejected.

Control panels

Control panels are available in 2 models. You can only operate a single registration unit per control panel. Any registration unit works with any control panel.



Product name	<i>ekey home CP mini 1</i>	<i>ekey home CP mini 2</i>	<i>ekey home CP micro 1</i>
Figure			
Mounting type	Mounting DIN rails 1 relay 1 digital input	Mounting DIN rails 2 relays	Integration into doors 1 relay, 1 digital input

Table 4: Control panel models and variants

Function of the control panel

The control panel is the actuator of the system. The control panel switches one or two relays and makes a digital input available for the models with one relay. The model with two relays does not have a digital input.

Controls and optical signals of the control panel

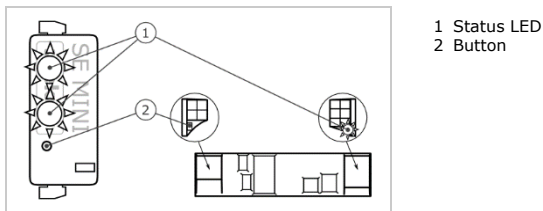

Fig. 6: Overview of *ekey home CP mini 1/2* and *ekey home CP micro 1*

ekey home control panel mini 1/2: The upper status LED indicates whether the control panel is connected to the finger scanner. The lower status LED indicates when a relay switches.

ekey home control panel micro 1: The LED indicates whether the control panel is connected to the finger scanner and whether the relay switches.

Button operation	Function
Press and hold button for 4 sec.	Reset to default settings.

Table 5: Button operation of *ekey home CP mini 1/2* and *ekey home CP micro 1*

Technical specifications

Name	Unit	Values
Supply	VDC	8–24
Power consumption	W	Heating off: 1 Heating on: 4
Temperature range	°C	-25 to +70
Memory	Fingers	99
	RFID transponders	99 (only for FS with RFID function)
Security	FAR	1:10,000,000
	FRR	1:100
IP code	IP	WM, IN: 54 (front side) OM: 44 (with ekey frame OM)
Reaction time	sec	1–2
Operational lifetime	Finger scans	Approx. 10 million
RFID (only for finger scanners with RFID function)	Interface	ISO14443A
	Transponder type	MIFARE DESFire EV1 with at least 1 KB of memory

Table 6: Technical specifications: ekey home finger scanner

Name	Unit	Values
Supply	VDC	8–24
Power consumption	W	Approx. 1
Temperature range	°C	-25 to +70
Memory	Codes	99
Pin code length	Quantity	4–8 digits
IP code	IP	54 (front side)
Speed	sec	<1 (after input is complete)
Operational lifetime	Button presses	Approx. 1 million

Table 7: Technical specifications: ekey home keypad integra 2.0

Name	Unit	Values		
		<i>ekey home CP mini 1</i>	<i>ekey home CP mini 2</i>	<i>ekey home CP micro 1</i>
Supply	VDC	8–24	8–24	8–24
Power consumption	W	Approx. 1	Approx. 1	Approx. 1
Relay	Quantity	1	2	1
Relay switching capacity	VAC/A VDC/A	42/2	42/2	42/2
Temperature range	°C	-20 to +70	-20 to +70	-25 to +60
IP code	IP	20	20	20
Digital inputs (only potential-free contacts may be connected)	Quantity	1	0	1

Table 8: Technical specifications: *ekey home control panel mini 1/2* and *ekey home control panel micro 1*

Installation and activation

Activating the system

ATTENTION



Mount and cable the product correctly before connecting power. Failure to do so will create a risk of possible property damage! Do not connect the power supply beforehand!



Mount the system in accordance with the supplied mounting instructions.





Cable the system in accordance with the supplied wiring diagram.



Using the finger scanner

Step	Action	Display
1st	Ensure safe installation of the devices. Close the covers.	-
2nd	Connect the power supply to the mains.	 <p>The top status LED on the <i>ekey home CP mini 1</i> and <i>ekey home CP mini 2</i> alternates between flashing green and orange and the LED on the <i>ekey home CP micro 1</i> flashes green slowly: default setting.</p>
3rd	No action required.	 <p>Status LED on the finger scanner flashes blue.</p>

Using the code pad

Step	Action	Display
1st	Ensure safe installation of the devices. Close the covers.	-
2nd	Connect the power supply to the mains.	 <p>The top status LED on the <i>ekey home CP mini 1</i> and <i>ekey home CP mini 2</i> flashes green and the LED on the <i>ekey home CP micro 1</i> flashes green slowly: default setting.</p>
3rd	No action required.	 <p>Status LEDs of the code pad do not light up.</p>

The devices have now been activated.

If you are using a Bluetooth finger scanner, the finger scanner is ready for storing administrator fingers and for creating the coupling between the finger scanner and mobile device.

The code pad is in normal mode.





You can check the cabling with the aid of test mode. Test mode only works for finger scanners.

NOTICE



A test can only take place if no administrator fingers have been stored and no mobile device has been coupled.

Connect the mains supply and perform the test within 5 minutes. If 5 minutes have elapsed, the mains supply will have to be reconnected in order to conduct this test.

Step	Action	Description	Display
1st		Place a finger on the sensor and leave it there for longer than 3 sec.	 The status LED flashes blue.
2nd		Remove the finger from the sensor within the next 2 sec.	 The status LED on the finger scanner lights up green. The top status LED on the <i>ekey home CP mini 1</i> or <i>ekey home CP mini 2</i> lights up green and the LED on the <i>ekey home CP micro 1</i> lights up green.

The relay switches.

NOTICE



This means that you can keep your finger on the sensor for up to 5 sec. If the finger is kept on the sensor for longer than this, the relay will not switch.

Operating concept

Different operating concepts are available, depending on the registration unit:

- *ekey home app* – administration of the Bluetooth finger scanner by means of a mobile device
- *ekey administrator finger* – administration of the finger scanner by means of administrator fingers
- *ekey admin code* – administration of the code pad by means of shortcuts.

Go to the operating concept that relates to the registration unit you have purchased.



See "Configuration of normal mode and usage of the finger scanner with the app", page 19.



See "Configuration of normal mode and usage of the finger scanner with administrator fingers", page 29.



See "Configuration of normal mode and usage of the code pad with shortcuts", page 41.

Configuration of normal mode and usage of the finger scanner with the app

NOTICE



The *ekey home app* can only be used in conjunction with the Bluetooth finger scanner.

The system must have been activated before you start your system administration.

See "Activating the system", page 15.



The Bluetooth finger scanner is ready to create the coupling between the Bluetooth finger scanner and mobile device. The *ekey home app* is used for programming the system. Doors can also be opened via the app.



The app is available for Apple iOS and Google Android. Download the *ekey home app* from the App Store or Google Play. To find it, enter the search term [ekey home app](#).

Downloading the app



Coupling a mobile device for the first time

For first-time coupling, you will need the device coupling code and the app security code. Both codes are factory-set as 9999.

Step	Instruction	Display
1st	Start the <i>ekey home app</i> .	
2nd	Touch the input field (Android) or press <u>Search</u> (iOS). The app searches for available Bluetooth devices.	-
3rd	Select your ekey Bluetooth finger scanner.	-
4th	Android only: Press <u>Login</u> .	-
5th	Enter the default device coupling code <u>9999</u> .	 The status LED lights up blue, the left-hand function LED lights up orange.
6th	Press <u>Next</u> . The mobile device is coupled with the Bluetooth finger scanner.	-
7th	Enter a new 6-digit device coupling code. For security reasons, you must change the default device coupling code the first time you perform the system admin coupling process. Make a note of this code, as you will need it to couple additional mobile devices.	-
8th	Write your new device coupling code here: _____.	-
9th	Press <u>Change</u> (Android) or <u>Next</u> (iOS).	-
10th	Enter the default app security code <u>9999</u> .	-
11th	Press <u>Next</u> .	-

The coupling between the Bluetooth finger scanner and the mobile device is established. The system is in normal mode.

You can now start programming and managing the finger scan access control system via the *ekey home app*.



NOTICE

The intuitive *ekey home app* is now all you need for the administration of your Bluetooth finger scanner. Tap the required functions in the app and follow the instructions on the display.

You can change all security codes at any time:

- the app security code
- the admin coupling code
- the user coupling code
- the control panel security code

NOTICE



The 4 to 6-digit app security code is required for the app security prompt. You can disable the prompt to enter the app security code under **ADMINISTRATION** if your mobile device supports secure lock mechanisms (fingerprint, code, etc.).

Step	Instruction
1st	Select ADMINISTRATION .
2nd	Select CHANGE SECURITY CODES .
3rd	Change the desired code.
4th	Press Change (Android) or Done (iOS).

The selected security code has been changed.

Storing fingers

You can store administrator and user fingers with the *ekey home app*.

Step	Instruction
1st	Select ADMINISTRATION .
2nd	Select USER ADMINISTRATION .
3rd	Press  (Android) or  (iOS).
4th	Enter the user name.
5th	Press <input type="text" value="New admin authorization"/> or <input type="text" value="New access authorization"/> .
6th	Select the relay to be switched.
7th	Select a finger.
8th	Press <input type="text" value="Store"/> .
9th	Read the notice and press <input type="text" value="Start"/> .
10th	Once your finger has been successfully registered, press <input type="text" value="OK"/> .
11th	Press <input type="text" value="Done"/> .



NOTICE

Store a minimum of one finger from each hand per access point.

The user fingers have been stored

The Bluetooth functionality can be disabled. Bluetooth functionality is set to enabled in the default settings.

Step	Instruction
1st	Start the <i>ekey home app</i> .
2nd	Select ADMINISTRATION .
3rd	Select SYSTEM STATUS .
4th	Under BLUETOOTH SETTINGS , enable the setting <u>Disable Bluetooth after 15 minutes.</u>

This setting disables Bluetooth on the finger scanner after 15 minutes if one of the following situations arises:

- No mobile device is connected
- At least one finger has been stored

You can re-enable Bluetooth: Access the admin menu and swipe any administrator finger over the sensor.

See “Storing user fingers”, page 31.





You can couple additional mobile devices with the Bluetooth finger scanner using the 6-digit admin/user coupling code you have chosen.

Coupling additional mobile devices

See “Storing the user coupling code”, page 25.



Step	Action	Description	Display
1st		Start the <i>ekey home app</i> .	-
2nd	Follow the instructions on the display	Couple the mobile device with the Bluetooth finger scanner using the 6-digit admin/user coupling code you have chosen.	 The status LED lights up blue, the left-hand function LED lights up orange.

The coupling between the Bluetooth finger scanner and the mobile device is established.

You can now start programming and managing the finger scan access control system via the *ekey home app*.

Managing multiple Bluetooth finger scanners

The *ekey home app* allows you to manage multiple Bluetooth finger scanners. To switch between two Bluetooth finger scanners, you must reset the coupling between the Bluetooth finger scanner and the mobile device.



NOTICE

When you reset the coupling, any relay names and user images that have been stored will be deleted. User names and authorizations will remain stored on the Bluetooth finger scanner.

Step	Instruction
1st	Start the <i>ekey home app</i> .
2nd	Select ADMINISTRATION .
3rd	Select RESET COUPLING .
4th	Confirm that you wish to carry out the reset by selecting <input type="button" value="Continue"/> .

The coupling between the Bluetooth finger scanner and the mobile device is reset.

You can now couple another Bluetooth finger scanner.



See [Coupling additional mobile devices](#), page 23.

Storing the user coupling code

The option is available to store a user coupling code. This can be passed on to a person of your choosing, who can then use it to perform the following actions with their mobile device:

- Open a door
- Enable/disable the app security code
- Change the app security code
- Reset the coupling between the finger scanner and their mobile device.

Step	Instruction
1st	Start the <i>ekey home app</i> .
2nd	Select ADMINISTRATION .
3rd	Select CHANGE SECURITY CODES .
4th	Enter the required user coupling code in the corresponding field.
5th	Confirm by selecting <input type="button" value="Change"/> (Android) or <input type="button" value="Done"/> (iOS).

The user coupling code was stored.

Resetting the app security code

If you have forgotten the app security code, you can use the app to reset the coupling between the Bluetooth finger scanner and the mobile device. When this reset is performed, the app security code is also reset to the default value of 9999.

Step	Instruction
1st	Start the <i>ekey home app</i> .
2nd	Enter an incorrect app security code.
3rd	Confirm by selecting <input type="button" value="Next"/> .
4th	Select RESET COUPLING .
5th	Confirm that you wish to carry out the reset by selecting <input type="button" value="Continue"/> .

The coupling between the Bluetooth finger scanner and the mobile device has been reset and the app security code set to 9999.

You can now recouple the Bluetooth finger scanner.

See Coupling additional mobile devices, page 23.



Protecting the system in the event that the mobile device is lost

If you have lost your mobile device, you can use a second mobile device to change the admin/user coupling code. This new admin/user coupling code will stop any connections being established using the lost mobile device.

Step	Instruction
1st	Start the <i>ekey home app</i> on the second mobile device.
2nd	Couple the second mobile device with the Bluetooth finger scanner.
3rd	Select ADMINISTRATION .
4th	Select CHANGE SECURITY CODES .
5th	Enter a new 6-digit admin/user coupling code.
6th	Confirm by selecting <input type="button" value="Change"/> (Android) or <input type="button" value="Done"/> (iOS).

The admin/user coupling code in the system has now been changed.

This means that the lost mobile device is no longer able to establish a connection to the Bluetooth finger scanner. Your system is protected against access by unauthorized persons once again.

The primary purpose of the product is to open doors. This can be carried out using the app, the finger scanner, an RFID transponder, or the digital input.

Using the app









The system is in normal mode.

Step	Instruction
1st	Start the <i>ekey home app</i> . The mobile device connects to the Bluetooth finger scanner.
2nd	Select ACCESSES .
3rd	Slide the slider of the door to be opened to the right.
4th	The door opens.

The system is in normal mode.

Using the finger scanner

The system is in normal mode.

Step	Action	Description	Display
1st		Swipe a stored finger over the sensor.	<div style="display: flex; flex-direction: column; align-items: center;"> <div style="display: flex; align-items: center;">   </div> <div style="margin-top: 10px;">   </div> </div> <div style="margin-top: 10px;"> <p>The status LED lights up green.</p> <p>The status LED lights up red.</p> </div>
		The finger was not recognized. Repeat step 1.	-
2nd	No action required.	The door opens.	<div style="display: flex; align-items: center;">  </div> <div style="margin-top: 10px;"> <p>The status LED lights up blue.</p> </div>

The system is in normal mode.

Using an RFID transponder



NOTICE

You can only open a door using an RFID transponder for finger scanners with an RFID function.

The system is in normal mode.

Step	Action	Description	Display	
1st		Hold a stored RFID transponder up to the finger swipe area of the finger scanner.		The status LED lights up green. Short beep.
				The status LED lights up red. Long beep.
			The RFID transponder was not recognized. Repeat step 1 with a valid RFID transponder.	-
2nd	No action required.	The door opens.		The status LED lights up blue.

The system is in normal mode.

Using the digital input (request-to-exit button function)

You can also open the door using the request-to-exit button function of the digital input on the control panel. The relay switches for the defined relay switch duration. If the digital input is enabled for longer than the defined relay switch duration, the relay switches for as long as the digital input is enabled.

Configuration of normal mode and usage of the finger scanner with administrator fingers

The devices must have been activated before you start your system administration.

See "Activating the system", page 15.



The finger scanner is ready to store the administrator fingers. The administrator fingers are used for programming the system. However, they are also able to open doors (like user fingers).

You must store 4 administrator fingers. We recommend storing 2 fingers of 2 different people for this purpose.

Storing administrator fingers and configuring normal mode

Step	Action	Description	Display
1st		Perform three Finger Touches on the sensor within 5 sec. This will take you to the Admin menu.	 Status LED lights up orange, function LEDs flash green.
2nd		Swipe administrator finger 1 over the sensor to store it. Repeat this step at least twice. Between each individual finger swipe, the finger scanner lights up orange if the finger storing process is not complete. During finger storage (after the first finger has been swiped over the sensor), no more than 10 sec may pass between each swipe. Otherwise, the finger storing process will be aborted.	 Status LED lights up green/All LEDs light up green.
			 Status LED and left-hand function LED light up green.
			 Status LED lights up red/All LEDs light up red.
			 Status LED lights up green, function LEDs light up red.
		The quality of the fingerprint is acceptable. However, it may be possible to improve the quality by swiping the finger again. If it has not been possible to obtain a very good-quality image after 6 fingerprints (😊), a good-quality image will be accepted.	

Step	Action	Description	Display
		Administrator finger 1 was not stored. Swipe the finger over the sensor again.	-
3rd	No action required.	-	 Status LED lights up orange, function LEDs flash green.
4th		To store administrator fingers 2, 3, and 4, carry out steps 2 and 3 for administrator fingers 2, 3, and 4.	 Status LED lights up blue.

All administrator fingers were successfully stored. The system is in normal mode.















NOTICE







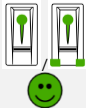

If, when the finger scanner is restarted, admin mode is active and fewer than 4 administrator fingers are present, all previously stored administrator fingers are deleted.

The system enables a maximum of 99 user fingers to be stored.

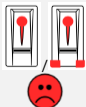
A user finger is any finger which is used for triggering an action on the control panel, e.g., opening a door. We recommend storing 2 fingers in each case.

The system is in normal mode.

Step	Action	Description	Display
1st		Perform three Finger Touches on the sensor within 5 sec. This will take you to the Admin menu.	 Status LED lights up blue, function LEDs light up green alternately.
2nd		Swipe any administrator finger over the sensor.	 Status LED lights up blue, function LEDs flash green.
			 Status LED lights up red.
		The administrator finger was not recognized. Swipe the finger over the sensor again.	-
3rd	Variant a  User finger for relay 1	Carry out a Finger Touch on the sensor within 5 sec.	 Status LED lights up orange, function LEDs flash green.
	Variant b  User finger for relay 2	Wait for 5 sec.	 Status LED lights up blue, function LEDs flash orange.
	Variant b  User finger for relay 2	Carry out a Finger Touch on the sensor within the next 5 sec.	 Status LED lights up orange, function LEDs flash orange.

Step	Action	Description	Display
4th		Swipe the user finger over the sensor to store it. Repeat this step at least twice. Between each individual finger swipe, the finger scanner lights up orange if the finger storing process is not complete. During finger storage (after the first finger has been swiped over the sensor), no more than 10 sec may pass between each swipe. Otherwise, the finger storing process will be aborted.	 Status LED lights up green/All LEDs light up green.
			 Status LED and left-hand function LED light up green.
			 Status LED lights up red/All LEDs light up red.
			 Status LED lights up green, function LEDs light up red.
		The quality of the fingerprint is acceptable. However, it may be possible to improve the quality by swiping the finger again.	
		The user finger was not stored. Repeat the procedure beginning at step 1. After 10 scans, the finger storing process is aborted.	
5th	No action required.	-	 Status LED lights up blue.

The user finger was stored. The system is in normal mode.



NOTICE

You can only store user fingers for relay 2 on the *ekey home CP mini 2*.

The system enables a maximum of 99 RFID transponders to be stored.

An RFID transponder is able to trigger an action on the control panel, e.g., opening a door.







NOTICE



You can only store an RFID transponder with finger scanners with an RFID function.

The system is in normal mode.

Step	Action	Description	Display	
1st		Perform three Finger Touches on the sensor within 5 sec. This will take you to the Admin menu.		Status LED lights up blue, function LEDs light up green alternately.
2nd		Swipe any administrator finger over the sensor.		Status LED lights up blue, function LEDs flash green.
				Status LED lights up red.
		The administrator finger was not recognized. Swipe the finger over the sensor again.	-	-
3rd	Variant a RFID transponder for relay 1	Carry out a Finger Touch on the sensor within 5 sec.		Status LED lights up orange, function LEDs flash green.
	Variant b RFID transponder for relay 2	Wait for 5 sec.		Status LED lights up blue, function LEDs flash orange.
	Variant b RFID transponder for relay 2	Carry out a Finger Touch on the sensor within the next 5 sec.		Status LED lights up orange, function LEDs flash orange.

Step	Action	Description	Display
4th		Hold the RFID transponder over the finger swipe area of the finger scanner at a distance of 1 to 5 cm.	<div style="display: flex; flex-direction: column; align-items: center;"> <div style="display: flex; align-items: center;">  <div style="margin-left: 10px;">All LEDs light up green. Short beep.</div> </div> <div style="display: flex; align-items: center; margin-top: 10px;">  <div style="margin-left: 10px;">Status LED lights up red. Long beep.</div> </div> </div>
	 	The RFID transponder was not stored. Either you did not hold the RFID transponder over the finger scanner for long enough, or it was not close enough, or this RFID transponder has already been stored. Repeat the procedure beginning at step 1.	-
5th	No action required.	-	<div style="display: flex; align-items: center;">  <div style="margin-left: 10px;">Status LED lights up blue.</div> </div>

The RFID transponder was stored. The system is in normal mode.









NOTICE

You can only store RFID transponders for relay 2 on the *ekey home CP mini 2*.

The primary purpose of the product is to open doors. This can be carried out using the finger scanner, an RFID transponder, or the digital input. The system is in normal mode.

Using the finger scanner

Step	Action	Description	Display
1st		Swipe a stored user finger over the sensor.	 Status LED lights up green.  Status LED lights up red.
		The user finger was not recognized. Repeat step 1.	-
2nd	No action required.	The door opens.	 Status LED lights up blue.







The system is in normal mode.

Using an RFID transponder

NOTICE



You can only open a door using an RFID transponder on finger scanners with an RFID function.

Step	Action	Description	Display
1st		Hold a stored RFID transponder up to the finger swipe area of the finger scanner.	 Status LED lights up green. Short beep.  Status LED lights up red. Long beep.
		The RFID transponder was not recognized. Repeat step 1 with a valid RFID transponder.	-
2nd	No action required.	The door opens.	 Status LED lights up blue.

The system is in normal mode.

Using the digital input (request-to-exit button)

You can also open the door using the digital input on the *ekey home CP mini 1* and *ekey home CP micro 1*. The relay switches for at least 3 sec. If the digital input is activated for more than 3 sec, the relay switches for as long as the digital input is enabled.





















NOTICE

This function does not exist for the *ekey home CP mini 2*, as there is no digital input available.

You can only delete individual fingers of a user if the person is present.

The system is in normal mode.

Step	Action	Description	Display
1st		Perform three Finger Touches on the sensor within 5 sec. This will take you to the Admin menu.	 Status LED lights up blue, function LEDs light up green alternately.
2nd		Swipe any administrator finger over the sensor.	 Status LED lights up blue, function LEDs flash green.  Status LED lights up red.
		The administrator finger was not recognized. Repeat step 1.	-
3rd	Variant a  Control panel with 1 relay	Wait for 5 sec.	 Status LED lights up blue, function LEDs flash red/green.
	Variant b  Control panel with 2 relays	Wait for 5 sec.	 Status LED lights up blue, function LEDs flash orange.
	Variant b  Control panel with 2 relays	Wait for a further 5 sec.	 Status LED lights up blue, function LEDs flash red/green.
4th		Carry out a Finger Touch on the sensor.	 Status LED lights up blue, function LEDs light up red on the left and green on the right.
5th		Swipe the user finger to be deleted over the sensor.	 Status LED flashes red, function LEDs light up red on the left and green on the right.
6th	No action required.	-	 Status LED lights up blue.

The user finger was deleted. The system is in normal mode.

Deleting RFID transponders

















You can only delete an individual RFID transponder if you have the RFID transponder to hand.



NOTICE

You can only delete RFID transponders on finger scanners with an RFID function.

The system is in normal mode.

Step	Action	Description	Display
1st		Perform three Finger Touches on the sensor within 5 sec. This will take you to the Admin menu.	 Status LED lights up blue, function LEDs light up green alternately.
2nd		Swipe any administrator finger over the sensor.	 Status LED lights up blue, function LEDs flash green.  Status LED lights up red.
	 	The administrator finger was not recognized. Repeat step 1.	-
3rd	Variant a  Control panel with 1 relay	Wait for 5 sec.	 Status LED lights up blue, function LEDs flash red/green.
	Variant b  Control panel with 2 relays	Wait for 5 sec.	 Status LED lights up blue, function LEDs flash orange.
	Variant b  Control panel with 2 relays	Wait for a further 5 sec.	 Status LED lights up blue, function LEDs flash red/green.
4th		Carry out a Finger Touch on the sensor.	 Status LED lights up blue, function LEDs light up red on the left and green on the right.
5th		Hold the RFID transponder to be deleted up to the finger swipe area of the finger scanner.	 Status LED flashes red, function LEDs light up red on the left and green on the right. Long beep.



















Step	Action	Description	Display
6th	No action required.	-	 Status LED lights up blue.



The RFID transponder was deleted. The system is in normal mode.

All user fingers and RFID transponders stored in the system are deleted. The administrator fingers are retained.

The system is in normal mode.

Deleting all user fingers and RFID transponders

Step	Action	Description	Display
1st		Perform three Finger Touches on the sensor within 5 sec. This will take you to the Admin menu.	 Status LED lights up blue, function LEDs light up green alternately.
2nd		Swipe any administrator finger over the sensor.	 Status LED lights up blue, function LEDs flash green.  Status LED lights up red.
		The administrator finger was not recognized. Repeat step 1.	-
3rd	Variant a  Control panel with 1 relay	Wait for 5 sec.	 Status LED lights up blue, function LEDs flash red/green.
	Variant b  Control panel with 2 relays	Wait for 5 sec.	 Status LED lights up blue, function LEDs flash orange.
	Variant b  Control panel with 2 relays	Wait for a further 5 sec.	 Status LED lights up blue, function LEDs flash red/green.
4th		Carry out a Finger Touch on the sensor.	 Status LED lights up blue, function LEDs light up red on the left and green on the right.
5th		Swipe the same administrator finger over the sensor as in step 1.	 Status LED flashes red/orange, function LEDs flash green.
6th	No action required.	-	 Status LED lights up blue.

Step	Action	Description	Display
7th		Swipe any user finger/RFID transponder over the sensor in order to verify. No finger/RFID transponder should now be able to gain access.	 Status LED lights up red.
8th	No action required.	-	 Status LED lights up blue.

All user fingers and RFID transponders were deleted. The system is in normal mode.

Configuration of normal mode and usage of the code pad with shortcuts

The devices must have been activated before you start your system administration.

See "Activating the system", page 15.



The system is in normal mode. The keypad is used for programming the system.

Entering the admin code grants you access to the Admin menu. The Admin menu is used to configure the system. The default admin code is 9999.

**Entering the
admin code**

ATTENTION













Change the default admin code immediately after activation!
If you do not change the admin code, it may be possible for unauthorized persons to get into your Admin menu and then gain access to your premises.
Choose a new admin code and keep it secret.

See "Changing the admin code", page 43.



The system is in normal mode.

Step	Action	Description	Display
1st		Press  to start the process of entering the admin code.	 Status LED lights up yellow on the left.
2nd		Enter the admin code on the keypad.	-
3rd		Press  .	 Status LED lights up green on the left.
			 Status LEDs light up red.
		The admin code was not recognized. Repeat the procedure beginning at step 1.	-

The system is in the Admin menu. It automatically switches back to normal mode if you do not press a button within 10 sec.















This function allows you to change the existing admin code. The admin code may contain between 4 and 8 digits. The digits cannot all be the same; at least one of them must be different.

The admin code can be changed via the Admin menu. Enter the admin code to access the Admin menu.

See “Entering the admin code”, page 41.

The system is in the Admin menu.

Step	Action	Description	Display	
1st		Press		Status LED lights up green on the left.
2nd		Press		Status LEDs light up green on the left and yellow on the right.
3rd		Enter the old admin code on the keypad.	-	-
4th		Press		Status LEDs light up yellow.
				Status LEDs light up red.
		The old admin code was not recognized. Enter the admin code from the beginning again.	-	-
5th		Enter the new admin code on the keypad.	-	-
6th		Press		Status LEDs light up yellow on the left and green on the right.
				Status LEDs light up red.
		The desired admin code has already been assigned as a user code. Enter the admin code from the beginning again.	-	-

Step	Action	Description	Display
7th		Enter the new admin code again on the keypad.	-
8th		Press  .	<div style="display: flex; justify-content: space-around; align-items: center;"> <div style="text-align: center;">   </div> <div style="text-align: center;">  </div> </div> <p>Status LEDs light up green.</p> <div style="display: flex; justify-content: space-around; align-items: center;"> <div style="text-align: center;">   </div> <div style="text-align: center;">  </div> </div> <p>Status LEDs light up red.</p>
		 The two entries do not match. The new admin code was not saved. Enter the admin code from the beginning again.	-
9th	No action required.	-	 <p>Status LEDs are off.</p>

The new admin code is saved. The system is in normal mode.

The brightness threshold for switching on the automatic back-illumination can be set using percentage values. By default, the brightness threshold is set to 50%. Enter the required percentage value:

- = automatic back-illumination off
- to = brightness threshold settings between highly sensitive and highly insensitive.

NOTICE



Alter the setting gradually to approach the required brightness threshold. The system responds very sensitively.

The automatic back-illumination is set via the Admin menu. Enter the admin code to access the Admin menu.

See "Entering the admin code", page 41.



The system is in the Admin menu.

Step	Action	Description	Display	
1st		Press <input type="text" value="5"/> , <input type="text" value="1"/> , and the <input type="text" value="value"/> of the required brightness threshold. E.g.: <input type="text" value="7"/> , <input type="text" value="0"/> for 70%.		Status LED lights up green on the left.
2nd		Press <input type="text" value="checkmark"/> .	 	Status LEDs light up green. Status LEDs light up red.
		Something has been entered incorrectly. The brightness threshold was not changed. Enter the admin code from the beginning again.	-	-
3rd	No action required.	-		Status LEDs are off.

The automatic back-illumination was set. The system is in normal mode.

Setting the brightness of the back-illumination

The brightness of the back-illumination can be set using 4 predefined modes. By default, the back-illumination is set to 100%. Enter the number of the required illumination:

- 0 = back-illumination off
- 1 = back-illumination at 33%
- 2 = back-illumination at 66%
- 3 = back-illumination at 100%.

The back-illumination brightness is set via the Admin menu. Enter the admin code to access the Admin menu.



See "Entering the admin code", page 41.

The system is in the Admin menu.

Step	Action	Description	Display
1st		Press 5 , 2 , and the number of the required mode. E.g.: 1 for 33%.	Status LED lights up green on the left.
2nd		Press	Status LEDs light up green. Status LEDs light up red.
		Something has been entered incorrectly. The brightness was not changed. Enter the admin code from the beginning again.	-
3rd	No action required.	-	Status LEDs are off.

The back-illumination brightness was set. The system is in normal mode.

Setting the relay switching duration

The switching duration for the relay can be set up to 99.9 in 0.1-second increments. Enter the required relay switching duration in tenths of a second. E.g.: for 6 sec; for 10 sec; for 30 sec. By default, the switching duration is set to 3 seconds. When the time is set to , the relay operates as a switch: The relay changes its switching status when a user code is detected and it remains in that status until another user code is detected.

The relay switching duration is set via the Admin menu. Enter the admin code to access the Admin menu.

See "Entering the admin code", page 41.



The system is in the Admin menu.

Step	Action	Description	Display	
1st	<input type="text" value="5"/> <input type="text" value="3"/>	Press <input type="text" value="5"/> , <input type="text" value="3"/> , then the number of the relay (<input type="text" value="1"/> or <input type="text" value="2"/>) and the <input type="text" value="value"/> of the required relay switching duration. E.g., <input type="text" value="1"/> , <input type="text" value="0"/> , <input type="text" value="0"/> for 10 sec.		Status LED lights up green on the left.
2nd	<input type="checkbox"/>	Press <input type="checkbox"/> .	 	Status LEDs light up green. Status LEDs light up red.
	<input type="checkbox"/>	Something has been entered incorrectly. The relay switching duration was not changed. Enter the admin code from the beginning again.	-	-
3rd	No action required.	-		Status LEDs are off.

The relay switching duration was set. The system is in normal mode.

NOTICE



You can only set the relay switching duration for relay 2 on the *ekey home CP mini 2*.

Setting the signaling that indicates when a button has been pressed

4 predefined modes can be used to set the acoustic and optical signaling that indicates when a button has been pressed. By default, the acoustic and optical signals indicating that a button has been pressed are on. Enter the number of the required mode:

- 0 = acoustic and optical signals off
- 1 = acoustic signals on and optical signals off
- 2 = acoustic signals off and optical signals on
- 3 = acoustic and optical signals on.

The signaling to indicate that a button has been pressed is set via the Admin menu. Enter the admin code to access the Admin menu.



See "Entering the admin code", page 41.

The system is in the Admin menu.

Step	Action	Description	Display
1st		Press , , and the of the required mode. E.g., for acoustic and optical signals off.	Status LED lights up green on the left.
2nd		Press .	Status LEDs light up green. Status LEDs light up red.
		Something has been entered incorrectly. The signaling was not changed. Enter the admin code from the beginning again.	-
3rd	No action required.	-	Status LEDs are off.

The optical and acoustic signaling to indicate that a button has been pressed was set. The system is in normal mode.

Setting an acoustic signal for opening

The acoustic signal for opening can be switched off and on. By default, the acoustic signal is switched on. Enter the number of the required status:

- 0 for switching off
- 1 for switching on.

The acoustic signal for opening is set via the Admin menu. Enter the admin code to access the Admin menu.

See "Entering the admin code", page 41.



The system is in the Admin menu.

Step	Action	Description	Display
1st		Press , and the number of the required status.	Status LED lights up green on the left.
2nd		Press .	Status LEDs light up green. Status LEDs light up red.
		Something has been entered incorrectly. The signaling was not changed. Enter the admin code from the beginning again.	-
3rd	No action required.	-	Status LEDs are off.

The acoustic signal for opening was set. The system is in normal mode.

Storing the user code

The system enables a maximum of 99 user codes to be stored.

A user code is any pin code which is used for triggering an action on the control panel, e.g., opening a door. The user code may contain between 4 and 8 digits. The digits cannot all be the same; at least one of them must be different.



NOTICE

To ensure the access control system remains secure, please remember the following when selecting a user code:

- Use long user codes
- Use only numbers if possible
- Do not use trivial codes.









The user codes are stored via the Admin menu. Enter the admin code to access the Admin menu.



See "Entering the admin code", page 41.

The system is in the Admin menu.

Step	Action	Description	Display	
1st		Press 1 and then the number of the required relay (1 or 2).		Status LED lights up green on the left.
2nd		Press		Status LEDs light up green.
3rd		Enter the required user code on the keypad.	-	-
4th		Press	 	Status LED lights up green on the right. Status LEDs light up red.
		The user code is already present. Enter the admin code from the beginning again.	-	-









Step	Action	Description	Display	
5th		Enter the required user code again on the keypad.	-	-
6th		Press  .		Status LEDs light up green.
				Status LEDs light up red.
		The two entries do not match. The user code was not stored. Enter the admin code from the beginning again.	-	-
7th	No action required.	-		Status LEDs are off.

The user code was stored. The system is in normal mode.

Opening a door

The primary purpose of the product is to open doors. This can be carried out using the code pad or the digital input. The system is in normal mode.

Using the code pad

Step	Action	Description	Display
1st		Enter a stored user code on the keypad.	-
2nd		Press  .	 Status LEDs light up green.  Status LEDs light up red.
		The user code was not recognized. Repeat the procedure beginning at step 1.	-
3rd	No action required.	The door opens.	 Status LEDs are off.

The system is in normal mode.



NOTICE

If the code is entered incorrectly 3 times, there will be a 1-minute lock. If the code is entered incorrectly another 3 times, there will be a 15-minute lock. There will be another 15-minute lock each time the code is entered incorrectly after that.

Using the digital input (request-to-exit button)

You can also open the door using the digital input on the *ekey home CP mini 1* and *ekey home CP micro 1*. The relay switches for the defined relay switching duration. If the digital input is enabled for longer than the defined relay switching duration, the relay switches for as long as the digital input is enabled.



NOTICE

This function does not exist for the *ekey home CP mini 2*, as there is no digital input available.

You can delete individual user codes for a user. To do this, you require the user code to be deleted.

A user code is deleted via the Admin menu. Enter the admin code to access the Admin menu.

See "Entering the admin code", page 41.



The system is in the Admin menu.

Step	Action	Description	Display	
1st		Press		Status LED lights up green on the left.
2nd		Press		Status LEDs light up green on the left and red on the right.
3rd		Enter the user code to be deleted on the keypad.	-	-
4th		Press		Status LEDs light up green.
				Status LEDs light up red.
		The user code is not known. The user code was not deleted. Enter the admin code from the beginning again.	-	-
5th	No action required.	-		Status LEDs are off.

The user code was deleted. The system is in normal mode.

Resetting the system to default settings

All authorizations are permanently deleted and the system settings are reset to their defaults. Your system is then in the condition in which it was delivered to you once more.



NOTICE

Effect of resetting to the default settings:

- All identification methods are deleted irretrievably. The admin code is reset to its default setting of 9999 using the code pad.
- The control panel and registration unit are no longer coupled together.
- The relay switching duration is set to 3 s.
- The LED intensity of the finger scanner is reset to 1 (LED dimmed).
- For a Bluetooth finger scanner, the admin coupling code is reset to the default setting of 9999.
- The brightness threshold of the automatic back-illumination is reset to 10% and the brightness value of the back-illumination to 100% using the code pad.
- The acoustic and optical signaling that indicates when a button has been pressed, and the acoustic signal for door opening, are both enabled again using the code pad.

You can reset the system to its default settings either via the app (Bluetooth finger scanners only), the registration unit, the control panel, or the digital input (*ekey home control panel micro 1* only). Use whichever device is most easily accessible.

The process of resetting to the default settings is initiated via the app.

NOTICE



The process of resetting to the default settings via the app is only possible for Bluetooth finger scanners.

Step	Instruction
1st	Start the <i>ekey home app</i> .
2nd	Connect to the Bluetooth finger scanner.
3rd	Select ADMINISTRATION .
4th	Select RESET SYSTEM .
5th	Confirm that you wish to carry out the reset by selecting Continue .

The system was reset to the default settings. You can now reactivate the system.

See "Configuration of normal mode and usage of the finger scanner with the app", page 19.



The process of resetting to the default settings is initiated via the finger scanner.

Via the finger scanner















NOTICE



At least 2 administrator fingers must be saved for the reset to be performed via the Bluetooth finger scanner.

The system is in normal mode.

Step	Action	Description	Display
1st		Carry out three Finger Touches on the sensor. This will take you to the Admin menu.	Status LED lights up blue, function LEDs light up green alternately.
2nd		Swipe any administrator finger over the sensor.	Status LED lights up blue, function LEDs flash green. Status LED lights up red.
		The administrator finger was not recognized. Repeat step 1.	-

Step	Action	Description	Display
3rd	Variant a  Control panel with 1 relay	Wait for 5 sec.	 Status LED lights up blue, function LEDs flash red/green.
	Variant b  Control panel with 2 relays	Wait for 5 sec.	 Status LED lights up blue, function LEDs flash orange.
	Variant b  Control panel with 2 relays	Wait for a further 5 sec.	 Status LED lights up blue, function LEDs flash red/green.
4th		Carry out a Finger Touch on the sensor.	 Status LED lights up blue, function LEDs light up red on the left and green on the right.
5th		Swipe a different administrator finger over the sensor than was used in step 2.	 Status LED flashes green, function LEDs flash red.
6th		Wait for 5 sec.	 Status LED flashes blue.
7th	No action required.	-	 The top status LED on the <i>ekey home CP mini 1/2</i> flashes orange/green and the LED on the <i>ekey home CP micro 1</i> flashes green slowly. 

The system was reset to its default settings. You can now reactivate the system.



See "Configuration of normal mode and usage of the finger scanner with administrator fingers", page 29.



See "Configuration of normal mode and usage of the finger scanner with the app", page 19.

The process of resetting to the default settings is initiated via the Admin menu of the code pad.

Enter the admin code to access the Admin menu.

See "Entering the admin code", page 41.



The system is in the Admin menu.

Step	Action	Description	Display	
1st		Press .		Status LED lights up green on the left.
2nd		Press .		Status LEDs light up red.
3rd		Enter the admin code on the keypad.	-	-
4th		Press .		Status LEDs are off.
				Status LEDs light up red.
		The admin code was not recognized. The system was not reset. Enter the admin code from the beginning again.	-	-
5th	No action required.	-		Status LEDs flash green alternately.
6th	No action required.	-		The top status LED on the <i>ekey home CP mini</i> 1/2 flashes green and the LED on the <i>ekey home CP micro</i> 1 flashes green slowly.





The system was reset to its default settings. You can now reactivate the system.

See "Configuration of normal mode and usage of the code pad with shortcuts", page 41.

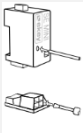

Via the control panel

The process of resetting to the default settings is initiated via the control panel.

Step	Action	Description	Display
1st		Press the button using the operating rod (<i>ekey home CP mini 1/2</i>) or a small screwdriver (<i>ekey home CP micro 1</i>) and hold it down for at least 4 sec.	 The status LED of the finger scanner flashes blue and the status LEDs of the code pad flash green alternately.
2nd	Variant a Finger scanner	-	 The top status LED on the <i>ekey home CP mini 1/2</i> flashes orange/green and the LED on the <i>ekey home CP micro 1</i> flashes green slowly.
3rd	Variant b Code pad	-	 The top status LED on the <i>ekey home CP mini 1/2</i> flashes green and the LED on the <i>ekey home CP micro 1</i> flashes green slowly.

The system was reset to the default settings. You can now reactivate the system.



See "Configuration of normal mode and usage of the finger scanner with administrator fingers", page 29.



See "Configuration of normal mode and usage of the finger scanner with the app", page 19.



See "Configuration of normal mode and usage of the code pad with shortcuts", page 41.

The process of resetting to the default settings is initiated via the digital input.

Step	Description
1st	Disconnect the <i>ekey home CP micro 1</i> from the mains supply.
2nd	Press and hold the request-to-exit button or short-circuit the pins for the digital input and keep them in this state.
3rd	Connect the <i>ekey home CP micro 1</i> to the mains supply.
4th	Keep the request-to-exit button held down or keep the pins for the digital input short-circuited for at least 5 sec.
5th	Release the request-to-exit button or remove the short-circuit. Within 5 sec, press and hold the request-to-exit button or short-circuit the pins for the digital input for at least 500 ms.

The system was reset to the default settings. You can now reactivate the system.

See "Configuration of normal mode and usage of the finger scanner with administrator fingers", page 29.



See "Configuration of normal mode and usage of the finger scanner with the app", page 19.



See "Configuration of normal mode and usage of the code pad with shortcuts", page 41.











Updating the software

We are working to improve our products and add new functions all the time. Correspondingly, updates are made available for the registration unit and control panel software. More information about this can be obtained from your dealer.







Error displays and troubleshooting

Finger scanner

Display	Meaning	Remedy
 Status LED lights up red.	The finger or RFID transponder was not recognized.	Swipe the finger over the sensor again. Check that your RFID transponder is the valid one.
 All LEDs light up red for 1 minute.	System lock. You used an unrecognized identification method 10 times in a row.	Wait for 1 minute. The system is then in normal mode.
 Status LED lights up red immediately.	No fingers or RFID transponders are stored.	Store a minimum of one finger or RFID transponder.
 Status LED flashes orange.	No bus connection to the control panel.	Check the wiring or activate the device.
 Status LED flashes red/green.	The sensor of the finger scanner without RFID function is soiled or broken.	Clean and/or dry the sensor.
 Status LED lights up blue, left-hand function LED flashes red/green.	The sensor of the finger scanner with RFID function is soiled or broken, but the RFID function still works.	Clean and/or dry the sensor.
 The status LED suddenly flashes blue when the device is in operation	This error display may have a number of causes.	Contact ekey support.
 All LEDs of a system not yet in operation are glowing red.	Lock mode. After connecting the system to the power supply, you have five minutes to activate the system and store fingers.	Disconnect the system from the power supply and then reconnect it. You can now store fingers.

Display	Meaning	Remedy
 <p data-bbox="153 81 260 165">The right function LED flashes orange</p>	<p data-bbox="277 81 482 127">You must change the operating concept.</p>	<p data-bbox="539 81 790 225">Switch from administration of the finger scanner via administrator finger to administration via mobile device.</p> <p data-bbox="539 232 790 351">If your finger scanner is not a Bluetooth finger scanner, reset your system to default settings and then reactivate it.</p>

If these remedies do not solve the problem, contact your dealer. If the system has to be returned to ekey biometric systems GmbH, ensure that it is correctly packaged. Improper packaging can lead to the warranty being voided.

Display	Meaning	Remedy
 Status LEDs light up red.	The user code was not recognized.	Enter the user code on the keypad again.
 Status LEDs light up red.	The numbers in the desired user code are all the same. E.g.: 1111, 3333.	Enter a new user code containing at least one number that is different from the others. E.g.: 1115, 3733.
 Status LEDs light up red.	The desired user code is too short or too long. E.g.: 321, 987654321.	Enter a new user code with a minimum of 4 digits and a maximum of 8 digits. E.g.: 4321, 87654321.
 Status LEDs light up red.	An error occurred when entering menu items or values.	Carefully read the description of the required function again.
 Status LED lights up red on the right.	An incorrect user code has been entered 3 times. 1-minute or 15-minute system lock.	After the 1-minute or 15-minute lock, enter a correct user code. The 1-minute or 15-minute lock will only count down if the power supply and data connection are present throughout.
 Status LEDs flash yellow alternately.	No bus connection to the control panel.	Check the wiring or activate the device.

If these remedies do not solve the problem, contact your dealer. If the system has to be returned to ekey biometric systems GmbH, ensure that it is correctly packaged. Improper packaging can lead to the warranty being voided.

Maintenance

The system is largely maintenance-free.

The sensor surface of the finger scanner is essentially self-cleaning due to repeated use (swiping of fingers). However, if the finger scanner becomes soiled, clean it with a damp (not wet), non-abrasive cloth. Q-tips, microfiber cloths, and glasses-cleaning cloths are suitable for this purpose. Cotton-containing materials, paper towels, tissues, kitchen sponges, damp dish towels, and kitchen roll are not suitable. Use clean water without adding detergent. Treat the sensor surface with care.

For safety, clean fingerprints and dirt off the code pad from time to time using a damp (not wet), non-abrasive cloth. Use clean water without adding detergent.

Disposal

Pursuant to Directive 2012/19/EU of the European Parliament and of the Council of 4 July 2012 on waste electrical and electronic equipment, electrical and electronic equipment supplied after August 13, 2005 is to be recycled. It must not be disposed of with household waste. As disposal regulations within the EU can differ from country to country, please contact your dealer for further information as necessary.



Austria

ekey biometric systems GmbH
Lunzerstraße 89, A-4030 Linz
Tel.: +43 732 890 500 0
office@ekey.net

Switzerland & Liechtenstein

ekey biometric systems Est.
Landstrasse 79, FL-9490 Vaduz
Tel.: +41 71 560 54 80
office@ekey.ch

Italy

ekey biometric systems Srl.
Via Copernico, 13/A, I-39100 Bolzano
Tel.: +39 0471 922 712
italia@ekey.net

Germany

ekey biometric systems Deutschland GmbH
Industriestraße 10, D-61118 Bad Vilbel
Tel.: +49 6187 906 96 0
office@ekey.net

Eastern Adriatic region

ekey biometric systems d.o.o.
Vodovodna cesta 99, SI-1000 Ljubljana
Tel.: +386 1 530 94 89
info@ekey.si



802248

ID203/731/0/669: Version 4, 2019-11-21
Media Center ID: 3004

www.ekey.net

Made in Austria

ekey biometric systems GmbH operates a quality management system in compliance with EN ISO 9001:2015 and is certified accordingly.